

ELECTROFUSION VALVE FLANGE

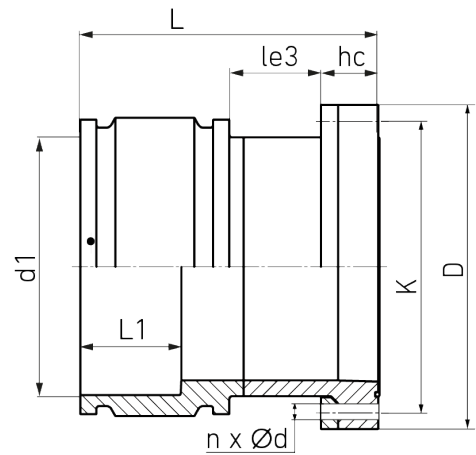

drilled according to DIN EN 1092-1 PN 16
 with EPDM-O-ring gasket and backing ring steel plastic coated
 optional with steel hot-dip galvanized or stainless steel backing ring
 4,0 mm pin

PE100-RC



SDR 11



Art. No.	DN [mm]	d1 [mm]	D [mm]	le3 [mm]	L [mm]	L1 [mm]	K [mm]	n	??d [mm]	hC [mm]	kg
3330981105600000	500	560	715	170	585	190	650	20	33	105	103,1

Other materials, dimensions and pressure classes on request

For questions, please feel free to contact us at: Tel. + 49 281
 98 414 - 0