

ELECTROFUSION VALVE FLANGE

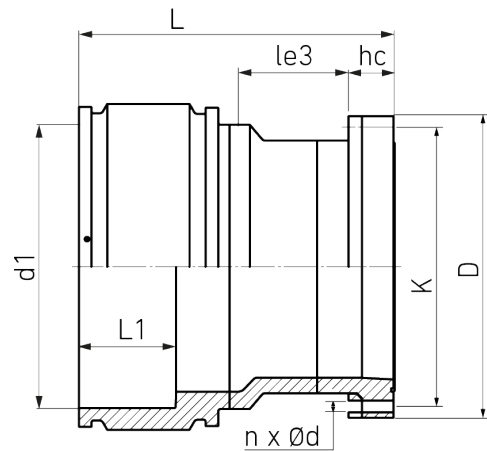

drilled according to DIN EN 1092-1 PN 16
 with EPDM-O-ring gasket and backing ring steel plastic coated
 optional with steel hot-dip galvanized or stainless steel backing ring
 4,0 mm pin

PE100-RC



SDR 11



| Art. No. | DN [mm] | d1 [mm] | D [mm] | le3 [mm] | L [mm] | L1 [mm] | K [mm] | n | ??d [mm] | hC [mm] | kg |
|------------------|------------|------------|-----------|-------------|-----------|------------|-----------|----|-------------|------------|-------|
| 3330981106300000 | 500 | 630 | 715 | 190 | 740 | 215 | 650 | 20 | 33 | 105 | 130,7 |

Other materials, dimensions and pressure classes on request

For questions, please feel free to contact us at: Tel. + 49 281
 98 414 - 0