

# ELBOW



45°

long spigot for butt- and electrofusion welding

PE100

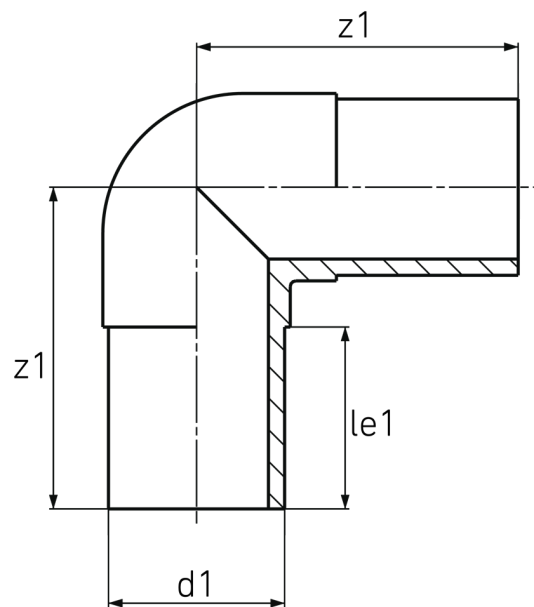

## SDR 9



Art. No.	d1 [mm]	le1 [mm]	z1 [mm]	kg
3414020900630000	63	68	85	0,25

Tolerance:  $\alpha \pm 2^\circ$

\* SRD 7,4 chamfered to SDR 9 (7.1 - 8.0 mm)

For questions, please feel free to contact us at: Tel. + 49 281 98 414 - 0