

ELBOW



45°

long spigot for butt- and electrofusion welding

PE100-RC

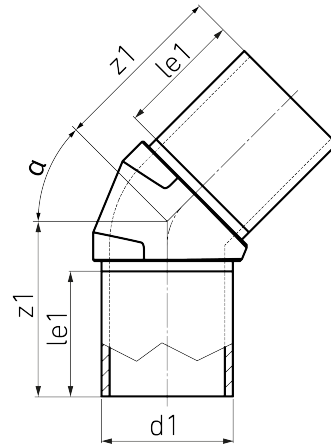

SDR 17



Art. No.	d1 [mm]	le1 [mm]	z1 [mm]	kg
3414041707100000	710	350	605	139,2

Tolerance: $\alpha \pm 5^\circ$

For questions, please feel free to contact us at: Tel. + 49 281 98 414 - 0