

female thread

PE100

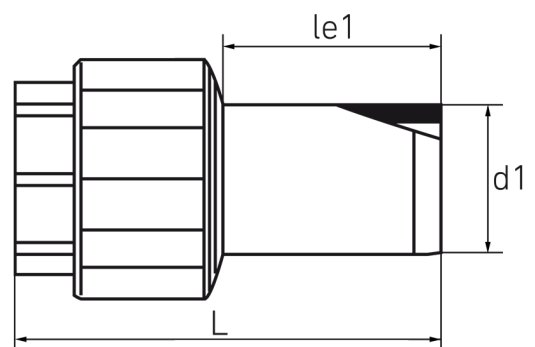

SDR 11

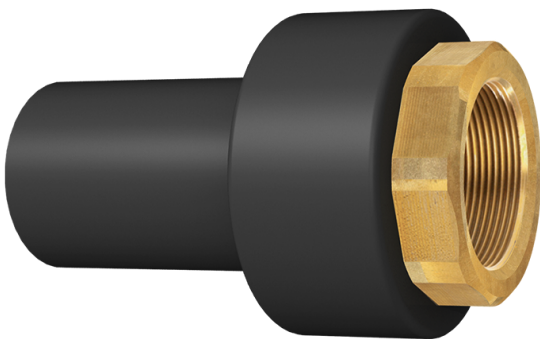

| Art. No. | d1 [mm] | Rp [mm] | le1 [mm] | L [mm] | kg |
|------------------|------------|------------|-------------|-----------|-----|
| 4150401100320000 | 32 | 1" | 48 | 88 | 0,3 |

For questions, please feel free to contact us at: Tel. + 49 281 98 414 - 0