

# BEND SEGMENT WELDED



11°

long spigot for butt- and electrofusion welding  
welded from pipe, non-reinforced

PP

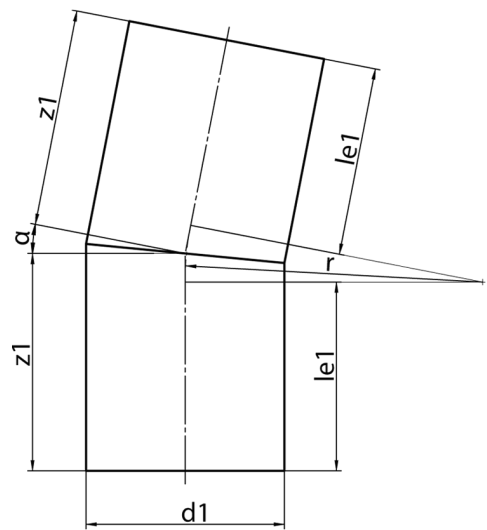

## SDR 11

fD  
0,8

Art. No.	d1 [mm]	le1 [mm]	z1 [mm]	r [mm]	kg
4211071101600000	160	206	214	240	2,5

other dimensions and pressure classes on request  
tolerance + / - 2°

For questions, please feel free to contact us at: Tel. + 49 281 98 414 - 0