

BLANKING FLANGE SET



drilled according to DIN EN 1092-1 PN 10

Set composed of:

loose flange PP glass fiber reinforced with steel inlay with PP-R end blank
optional with threaded connection

PP

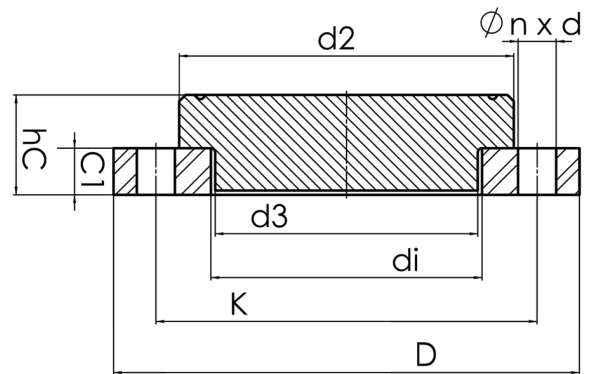

Art. No.	DN [mm]	d1 [mm]	d2 [mm]	d3 [mm]	D [mm]	K [mm]	n	ød [mm]	C1 [mm]	hc [mm]	kg
4213150001100100	100	110	158	123	221	180	8	18	22	47	2,1

other dimensions and pressure classes on request
PFA = maximum allowable operating pressure (20°)

For questions, please feel free to contact us at: Tel. + 49 281 98
414 - 0