

r = 1 x d  
 injection moulded  
 short spigot for butt welding

PP

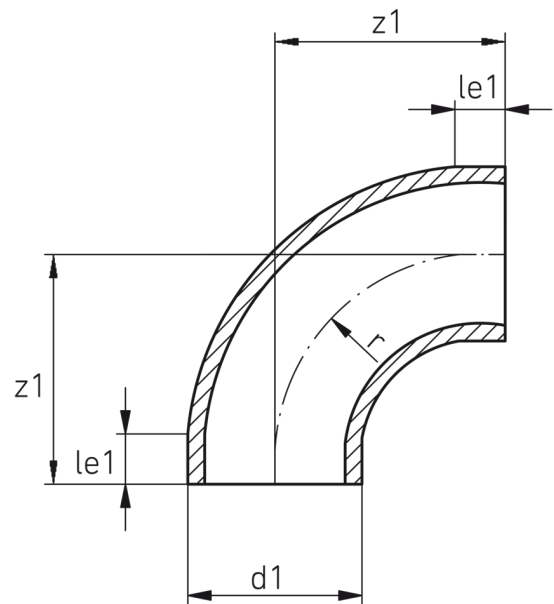

**SDR 11**

Art. No.	d1 [mm]	le1 [mm]	z1 [mm]	r [mm]	kg
4219901101800000	180	15	195	180	2,9

Other materials on request

For questions, please feel free to contact us at: Tel. + 49 281 98 414 - 0