

r = 1 x d
 injection moulded
 short spigot for butt welding

PP

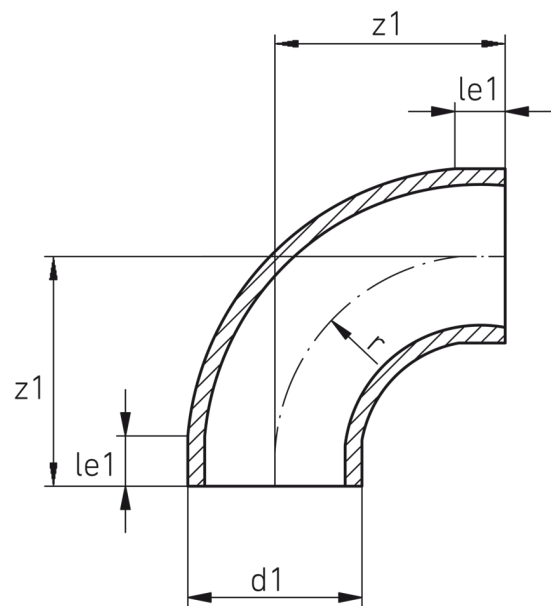

SDR 11

Art. No.	d1 [mm]	le1 [mm]	z1 [mm]	r [mm]	kg
4219901103150000	315	35	350	315	14,6

Other materials on request

For questions, please feel free to contact us at: Tel. + 49 281 98 414 - 0