

STUB END

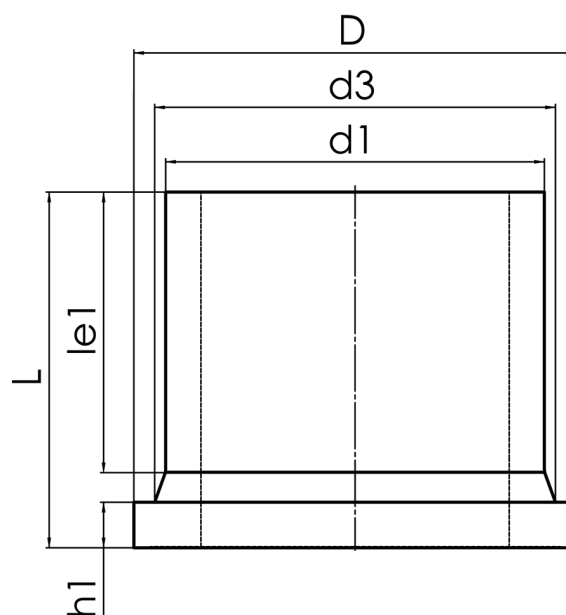

long spigot for butt- and electrofusion welding
 pressure load according to DVS 2210-1 Supplement 3 Part 2.1

PP



SDR 11

Art. No.	d1 [mm]	d3 [mm]	D [mm]	le1 [mm]	L [mm]	h1 [mm]	kg
4230041100750000	75	89	122	89	126	16	0,3

Other materials and pressure classes on request

For questions, please feel free to contact us at: Tel. + 49 281 98 414 - 0