

# TEE REDUCED

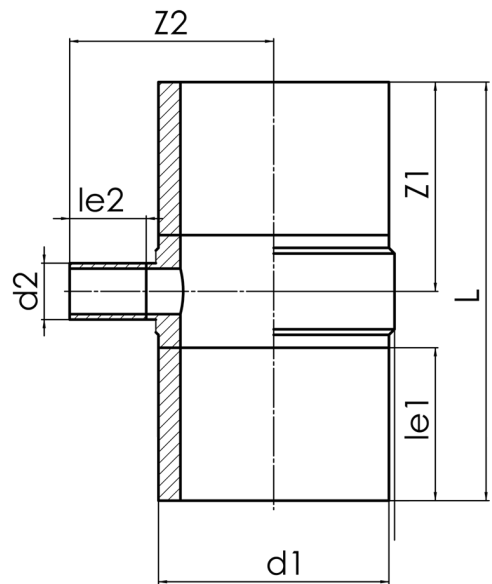

long spigot for butt- and electrofusion welding

PP



## SDR 11



Art. No.	d1 [mm]	d2 [mm]	le1 [mm]	le2 [mm]	L [mm]	z1 [mm]	z2 [mm]	kg
4232301102500110	250	110	250	150	726	306	363	12,5

other dimensions and pressure classes on request

For questions, please feel free to contact us at: Tel. + 49 281 98 414 - 0