

TEE REDUCED

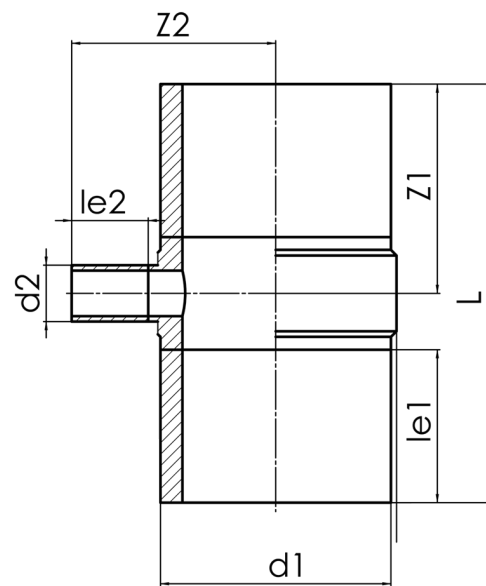

long spigot for butt- and electrofusion welding

PP



SDR 17,6



Art. No.	d1 [mm]	d2 [mm]	le1 [mm]	le2 [mm]	L [mm]	z1 [mm]	z2 [mm]	kg
4232301802500090	250	90	250	150	706	353	306	8,3

other dimensions and pressure classes on request

For questions, please feel free to contact us at: Tel. + 49 281 98 414 - 0