

TEE REDUCED

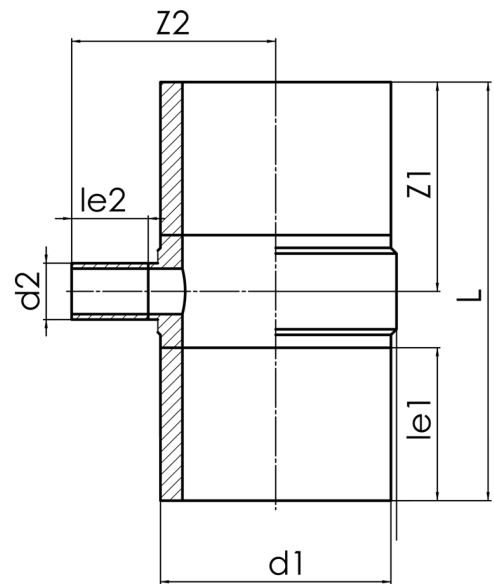

long spigot for butt- and electrofusion welding

PP



SDR 17,6



| Art. No. | d1 [mm] | d2 [mm] | le1 [mm] | le2 [mm] | L [mm] | z1 [mm] | z2 [mm] | kg |
|------------------|------------|------------|-------------|-------------|-----------|------------|------------|----|
| 4232301803150160 | 315 | 160 | 300 | 150 | 877 | 439 | 338 | 17 |

other dimensions and pressure classes on request

For questions, please feel free to contact us at: Tel. + 49 281 98 414 - 0