

TEE REDUCED

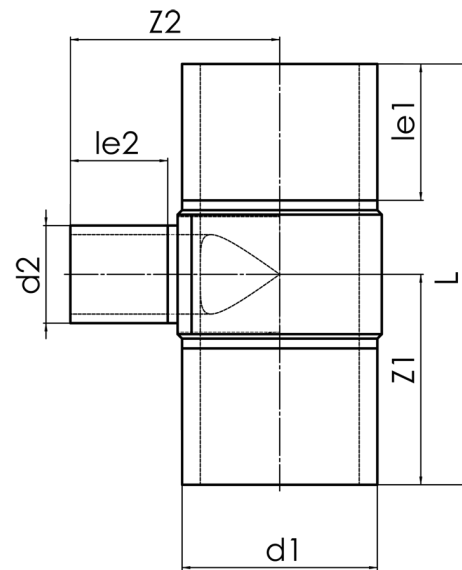

long spigot for butt- and electrofusion welding
to completely drain the pipeline

PP

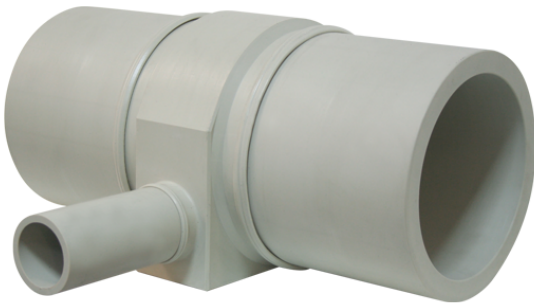

SDR 11



Art. No.	d1 [mm]	d2 [mm]	le1 [mm]	le2 [mm]	L [mm]	z1 [mm]	z2 [mm]	kg
4232311105000140	500	140	350	150	970	485	437	63,7

other dimensions and pressure classes on request

For questions, please feel free to contact us at: Tel. + 49 281 98 414 - 0