

# TEE REDUCED

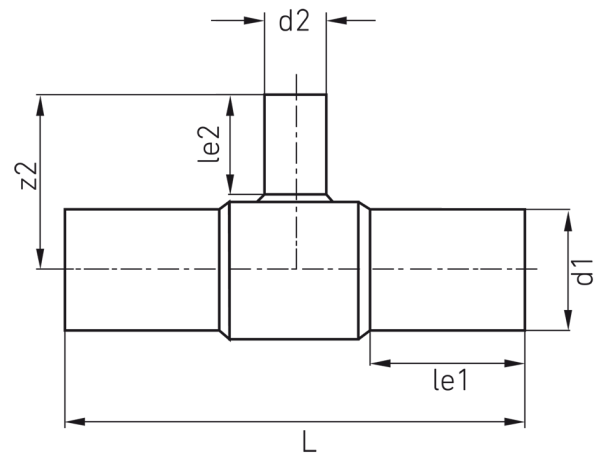

long spigot for butt- and electrofusion welding

PP



## SDR 11

Art. No.	d1 [mm]	d2 [mm]	le1 [mm]	le2 [mm]	L [mm]	z2 [mm]	kg
4232501102250110	225	110	120	85	449	226	6,7

Other materials and pressure classes on request

For questions, please feel free to contact us at: Tel. + 49 281 98 414 - 0