

REDUCER ECCENTRIC

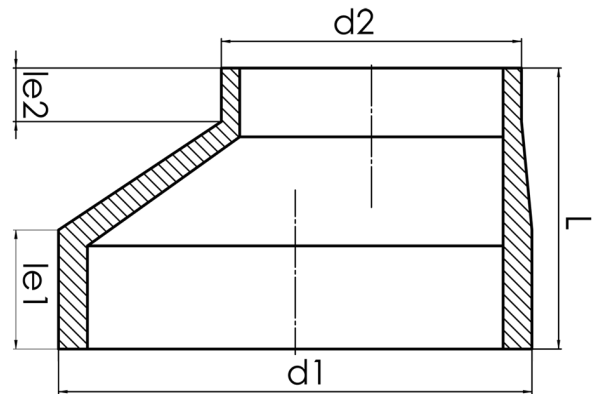

short spigot for butt welding
to completely drain the pipeline

PP



SDR 11



Art. No.	d1 [mm]	d2 [mm]	le1 [mm]	le2 [mm]	L [mm]	kg
4234111102800225	280	225	62	40	140	2,4

other dimensions and pressure classes on request

For questions, please feel free to contact us at: Tel. + 49 281 98 414 - 0