

# REDUCER ECCENTRIC

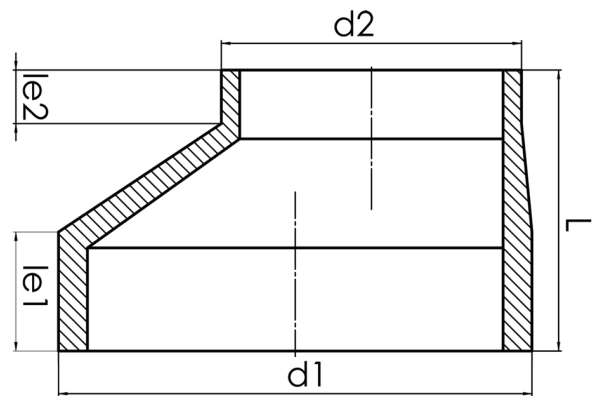

short spigot for butt welding  
to completely drain the pipeline

PP



## SDR 17,6



Art. No.	d1 [mm]	d2 [mm]	le1 [mm]	le2 [mm]	L [mm]	kg
4234111804000250	400	250	98	40	231	5,3

other dimensions and pressure classes on request

For questions, please feel free to contact us at: Tel. + 49 281 98 414 - 0