

long spigot for butt- and electrofusion welding
welded from pipe, non-reinforced

PP

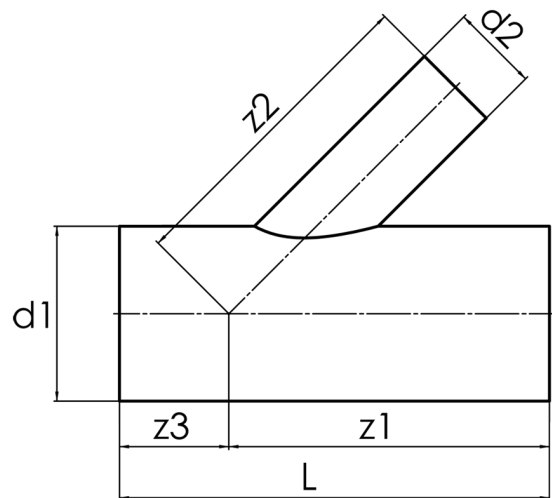

SDR 11



Art. No.	d1 [mm]	d2 [mm]	L [mm]	z1 [mm]	z2 [mm]	z3 [mm]	kg
4242861104500200	450	200	850	555	555	295	43,2

other dimensions and pressure classes on request
tolerance + / - 2°

For questions, please feel free to contact us at: Tel. + 49 281 98 414 - 0