

TECHNICAL DATA SHEET
BRANCH EQUAL



60°

long spigot for butt- and electrofusion welding
 welded from pipe, non-reinforced

PP

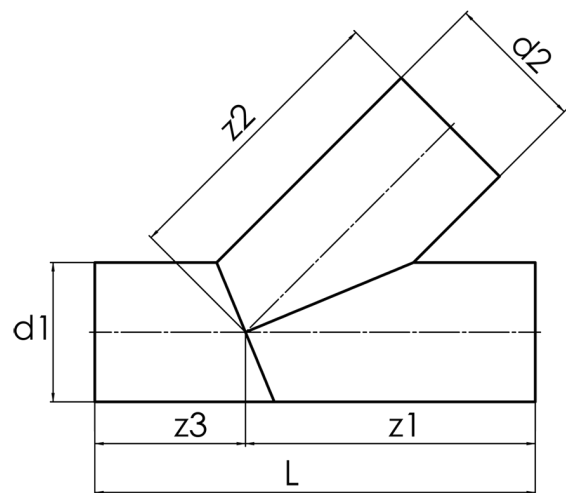

SDR 11



Art. No.	d1 [mm]	d2 [mm]	L [mm]	z1 [mm]	z2 [mm]	z3 [mm]	kg
4242861104500450	450	450	1220	740	740	480	78,3

other dimensions and pressure classes on request
 tolerance + / - 2°

For questions, please feel free to contact us at: Tel. + 49 281 98 414 - 0