

long spigot for butt- and electrofusion welding

PP

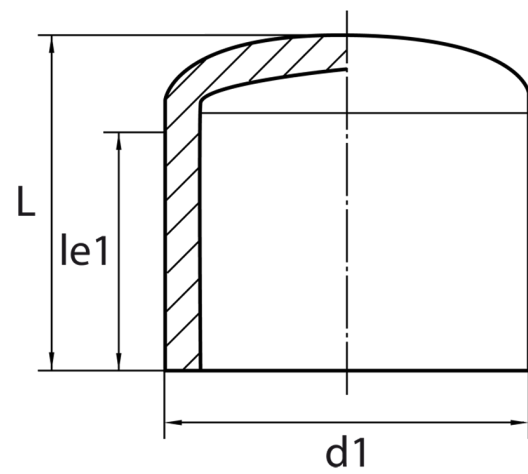

SDR 11

Art. No.	d1 [mm]	le1 [mm]	L [mm]	kg
4245041101800000	180	141	191	1,6

Other materials and pressure classes on request

For questions, please feel free to contact us at: Tel. + 49 281 98 414 - 0