

TRANSITION COUPLER

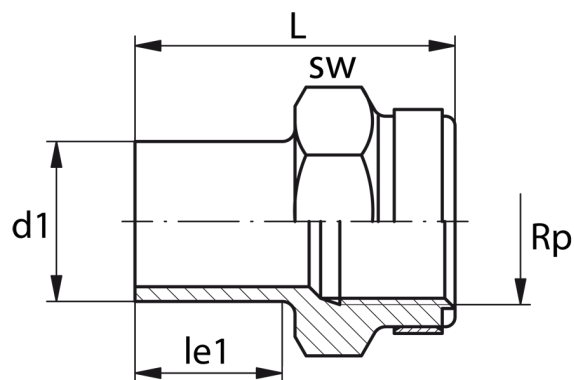

female thread
 reinforcing ring stainless (V2A)
 connection to plastic or metal threads
 do not use thread sealing pastes that are harmful to PE
 install with low mechanical stress and avoid large cyclic temperature changes

PP



SDR 11

Art. No.	d1 [mm]	Rp [mm]	le1 [mm]	L [mm]	SW [mm]	kg
4250111100200012	20	??"	23	48	32	0,02

For questions, please feel free to contact us at: Tel. + 49 281 98 414 - 0