

# HOLLOW BAR

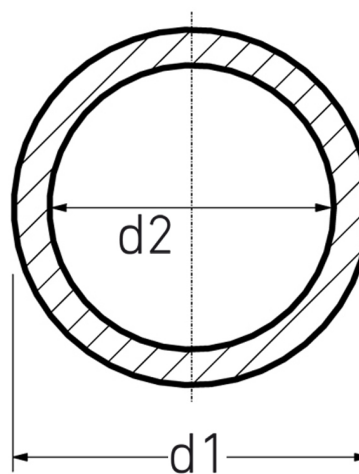

standard length 2.000 mm (pre-cut parts on request)  
 fabrication tolerances according to prior agreement

PP



Art. No.	d1 [mm]	d2 [mm]	kg
4282000009300435	930	435	1018,9

Other dimensions and materials on request

For questions, please feel free to contact us at: Tel. + 49 281 98 414 - 0