

12 m lengths
 Waste water pressure pipe, with strips, conform to DIN 8074/8075,
 DIN EN 12201, PAS 1075 TYP I, black / brown

PE100-RC

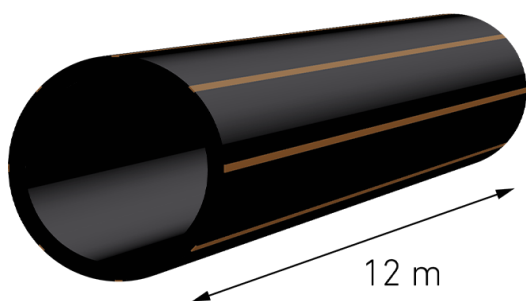

SDR 11

Art. No.	d1 [mm]	e [mm]	VE	VE [Ma??e]	kg	kg/m
4310141103150012	315	28,6	8	1050 x 415	0	25,9

Individual lengths, other materials and pressure classes on request
 * from d 710 mm = 12,5 m

For questions, please feel free to contact us at: Tel. + 49 281 98 414 - 0