

watertight till d 315 mm up to 3 bar, from d 355 mm up to 1 bar

PE100-RC

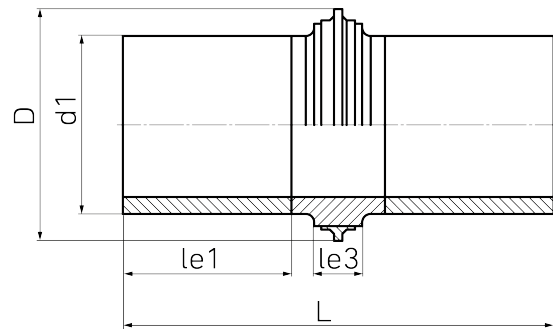

SDR 17



Art. No.	d1 [mm]	D [mm]	le1 [mm]	le3 [mm]	L [mm]	kg
4312341703150000	315	460	300	85	765	16,1

For questions, please feel free to contact us at: Tel. + 49 281 98 414 - 0