

BLANKING FLANGE SET



drilled according to DIN EN 1092-1 PN 10

Set composed of:

loose flange PP glass fiber reinforced with steel inlay with PE 100 end blank
optional with threaded connection

PE100

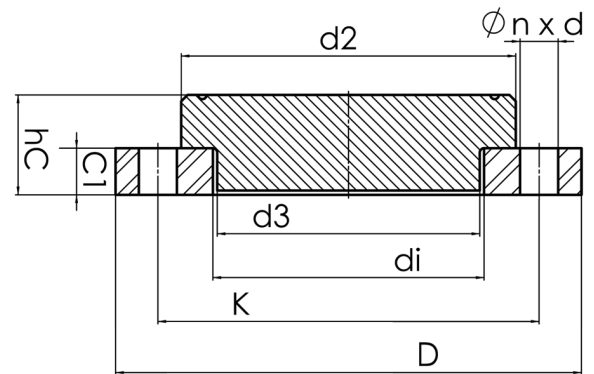

Art. No.	DN [mm]	d1 [mm]	d2 [mm]	d3 [mm]	D [mm]	K [mm]	n	ød [mm]	C1 [mm]	hc [mm]	PFA [bar]	kg
4313150006300600	600	630	685	640	789	725	20	30	50	130	10	76,1

Other materials, dimensions and pressure classes on request

PFA = maximum allowable operating pressure (20°)

For questions, please feel free to contact us at: Tel. + 49 281 98 414 - 0