

SEAMLESS BEND



90°

$r \approx 2,5 \times d$
long spigot for butt- and electrofusion welding

PE100-RC

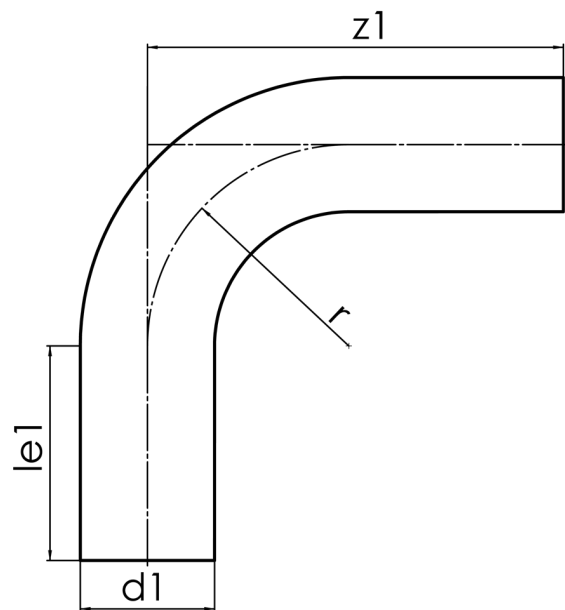

SDR 11



Art. No.	d1 [mm]	le1* [mm]	z1 [mm]	r [mm]	kg
4319051100400000	40	100	250	125	0,28

other dimensions, materials and pressure classes on request

Tolerance: $\alpha \pm 5^\circ$ | $z1 \pm 50$ mm

* minimum „le1“

For questions, please feel free to contact us at: Tel. + 49 281 98 414 - 0