

long spigot for butt- and electrofusion welding  
welded from pipe

PE100-RC

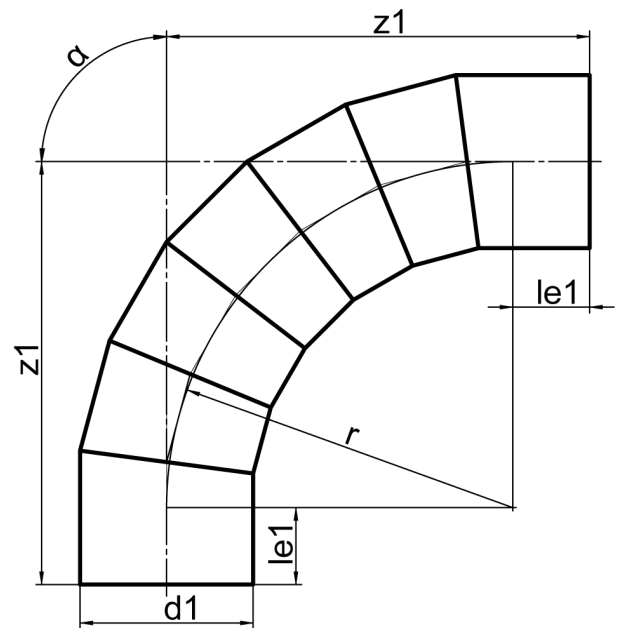

**SDR 17**

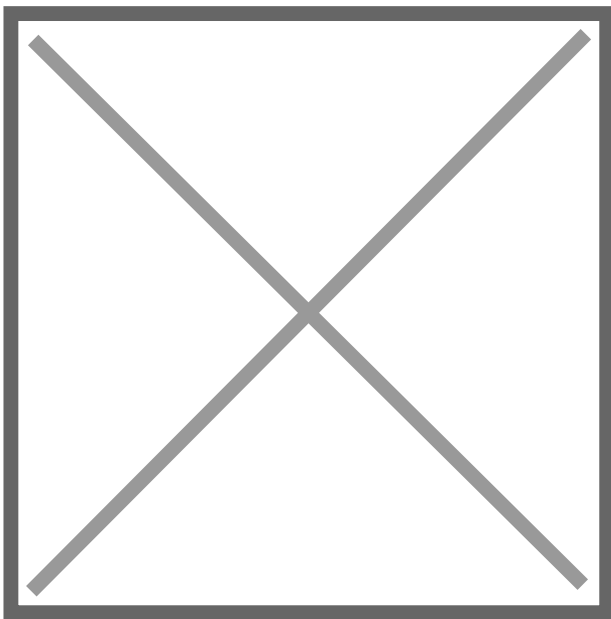

Art. No.	d1 [mm]	le1 [mm]	z1 [mm]	r [mm]	kg
4319171703550000	355	300	1350	1050	47,5

Other materials, dimensions and pressure classes on request  
tolerance + / - 2°

For questions, please feel free to contact us at: Tel. + 49 281 98 414 - 0