

90°

ri ≈ 1100 mm
long spigot for butt- and electrofusion welding

PE100-RC

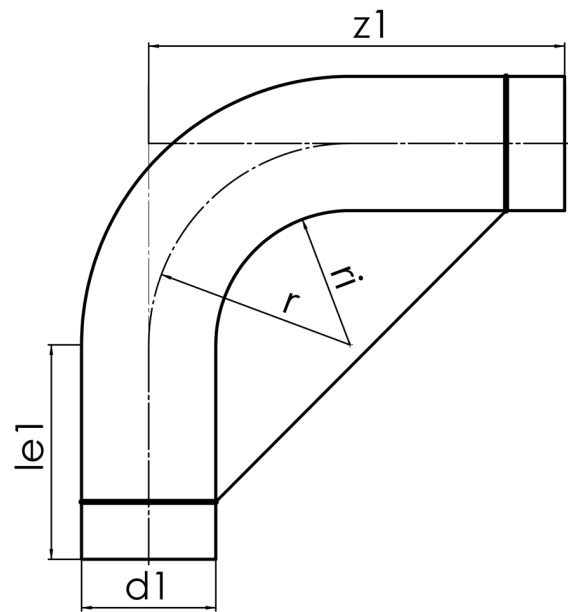

SDR 11



Art. No.	d1 [mm]	le1* [mm]	z1 [mm]	r [mm]	kg
4319711101400000	140	150	1500	1,17	12,18

Tolerance: $\alpha \pm 5^\circ$ | $z1 \pm 100$ mm
necessary fixations will be charged seperately and credited completely by carriage free returning
* minimum „le1“

For questions, please feel free to contact us at: Tel. + 49 281 98 414 - 0