

# SEAMLESS BEND



90°

ri ≈ 1750 mm  
long spigot for butt- and electrofusion welding

PE100-RC

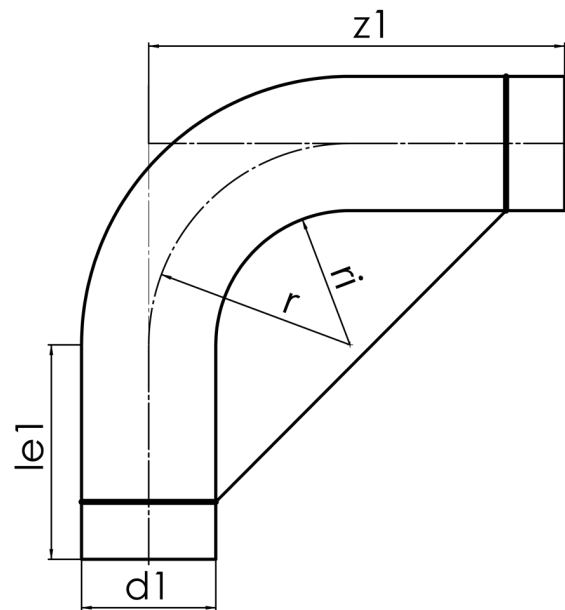

## SDR 17



Art. No.	d1 [mm]	le1* [mm]	z1 [mm]	r [mm]	kg
4319721705000000	500	350	2620	2	184,39

Tolerance:  $\alpha \pm 5^\circ$  |  $z1 \pm 100$  mm  
 necessary fixations will be charged seperately and credited completely by  
 carriage free returning  
 \* minimum „le1“

For questions, please feel free to contact us at: Tel. + 49 281 98 414 - 0