

PE100-RC

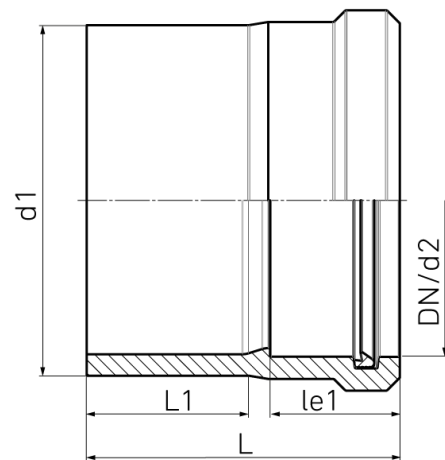

SDR 11

| Art. No. | DN [mm] | d1 [mm] | d2 [mm] | le1 [mm] | L [mm] | L1 [mm] | kg |
|------------------|------------|------------|------------|-------------|-----------|------------|------|
| 4320601101600160 | 150 | 160 | 160 | 98 | 199 | 74 | 1,39 |

For questions, please feel free to contact us at: Tel. + 49 281 98 414 - 0