

PE100-RC

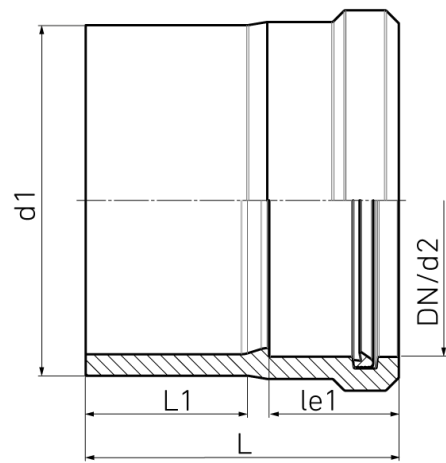

**SDR 11**

Art. No.	DN [mm]	d1 [mm]	d2 [mm]	le1 [mm]	L [mm]	L1 [mm]	kg
4320601103550315	300	355	315	164	330	132	9,97

For questions, please feel free to contact us at: Tel. + 49 281 98 414 - 0