

drilled according to DIN EN 1092-1 PN 10  
 with EPDM-O-ring gasket and backing ring steel plastic coated  
 optional with steel hot-dip galvanized or stainless steel backing ring  
 short spigot for butt welding

PE100-RC

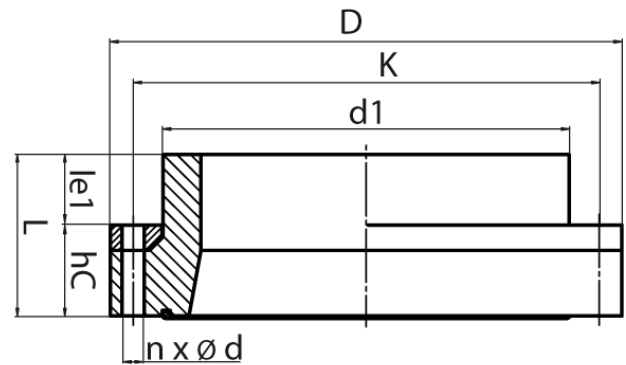

**SDR 17**



Art. No.	DN [mm]	d1 [mm]	D [mm]	le1 [mm]	L [mm]	K [mm]	n	??d [mm]	M	hc [mm]	kg
4330201705600500	500	560	670	70	170	620	20	26	24	100	36,4

Other materials, dimensions and pressure classes on request

\* available for gas pipes with flat surface or NBR-Gaskets

For questions, please feel free to contact us at: Tel. + 49 281 98  
 414 - 0