

drilled according to DIN EN 1092-1 PN 10
 with EPDM-O-ring gasket and backing ring steel plastic coated
 optional with steel hot-dip galvanized or stainless steel backing ring
 short spigot for butt welding

PE100-RC

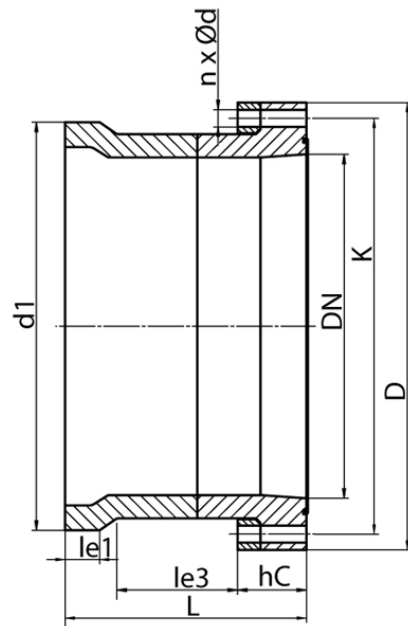

SDR 17



Art. No.	DN [mm]	d1 [mm]	D [mm]	le1 [mm]	le3 [mm]	L [mm]	K [mm]	n	Ød [mm]	M	hC [mm]	kg
4330201706300500	500	630	670	60	190	380	620	20	26	24	100	50,4

Other materials, dimensions and pressure classes on request
 * available for gas pipes with flat surface or NBR-Gaskets

For questions, please feel free to contact us at: Tel. + 49 281 98 414 - 0