

drilled according to DIN EN 1092-1 PN 16  
 with EPDM-O-ring gasket and backing ring steel plastic coated  
 optional with steel hot-dip galvanized or stainless steel backing ring  
 short spigot for butt welding

PE100-RC

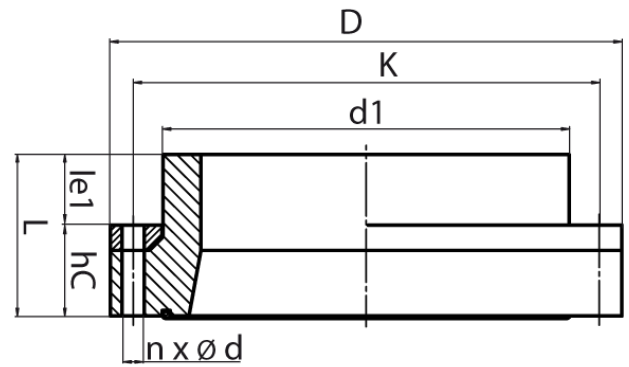

**SDR 11**



Art. No.	DN [mm]	d1 [mm]	D [mm]	le1 [mm]	L [mm]	K [mm]	n	??d [mm]	M	hc [mm]	kg
4330301104000350	350	400	520	70	165	470	16	26	24	95	28,3

Other materials, dimensions and pressure classes on request

\* available for gas pipes with flat surface or NBR-Gaskets

For questions, please feel free to contact us at: Tel. + 49 281 98 414 - 0