

drilled according to DIN EN 1092-1 PN 10/16
 with EPDM-O-ring gasket and backing ring steel plastic coated
 optional with steel hot-dip galvanized or stainless steel backing ring
 long spigot for butt- and electrofusion welding

PE100-RC

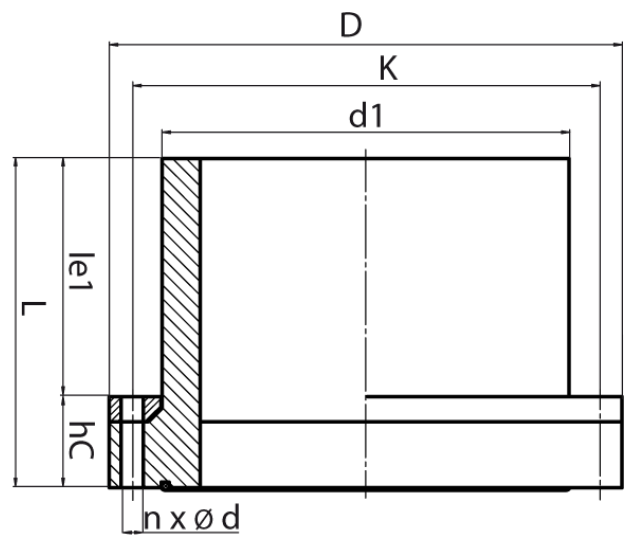

SDR 11



| Art. No. | DN [mm] | d1 [mm] | D [mm] | le1 [mm] | L [mm] | K [mm] | n | ??d [mm] | M | hC [mm] | kg |
|------------------|------------|------------|-----------|-------------|-----------|-----------|---|-------------|----|------------|-----|
| 4330501100900065 | 65 | 90 | 185 | 110 | 150 | 145 | 4 | 18 | 16 | 40 | 2,2 |

Other materials, dimensions and pressure classes on request

* available for gas pipes with flat surface or NBR-Gaskets

For questions, please feel free to contact us at: Tel. + 49 281 98 414

- 0