

drilled according to DIN EN 1092-1 PN 10/16
 with EPDM-O-ring gasket and backing ring steel plastic coated
 optional with steel hot-dip galvanized or stainless steel backing ring
 long spigot for butt- and electrofusion welding

PE100-RC

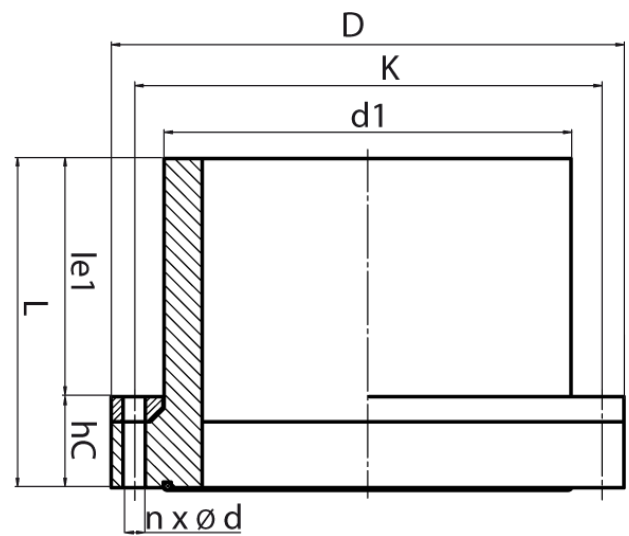

SDR 17



Art. No.	DN [mm]	d1 [mm]	D [mm]	le1 [mm]	L [mm]	K [mm]	n	??d [mm]	M	hc [mm]	kg
4330501701100080	80	110	200	115	155	160	8	18	16	40	2,4

Other materials, dimensions and pressure classes on request

* available for gas pipes with flat surface or NBR-Gaskets

For questions, please feel free to contact us at: Tel. + 49 281 98 414

- 0