

drilled according to DIN EN 1092-1 PN 10
 with EPDM-O-ring gasket and backing ring steel plastic coated
 optional with steel hot-dip galvanized or stainless steel backing ring
 long spigot for butt- and electrofusion welding

PE100-RC

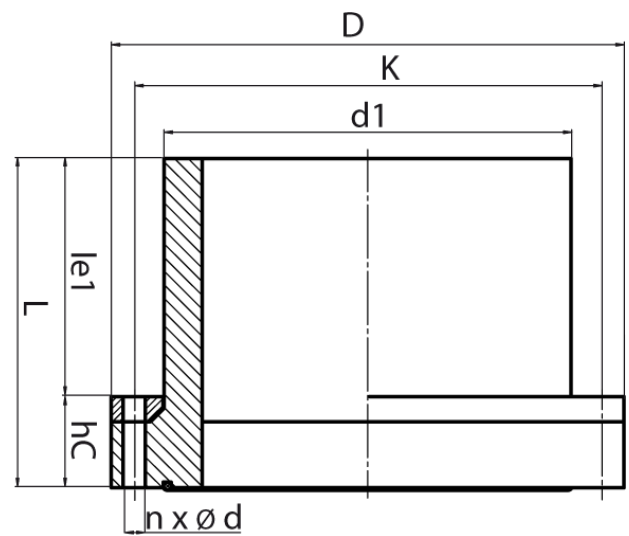

SDR 17



Art. No.	DN [mm]	d1 [mm]	D [mm]	le1 [mm]	L [mm]	K [mm]	n	??d [mm]	M	hc [mm]	kg
4330601703550300	300	355	445	210	270	400	12	22	20	60	15,3

Other materials, dimensions and pressure classes on request

* available for gas pipes with flat surface or NBR-Gaskets

For questions, please feel free to contact us at: Tel. + 49 281 98
 414 - 0