

drilled according to DIN EN 1092-1 PN 16
 with EPDM-O-ring gasket and backing ring steel plastic coated
 optional with steel hot-dip galvanized or stainless steel backing ring
 long spigot for butt- and electrofusion welding

PE100-RC

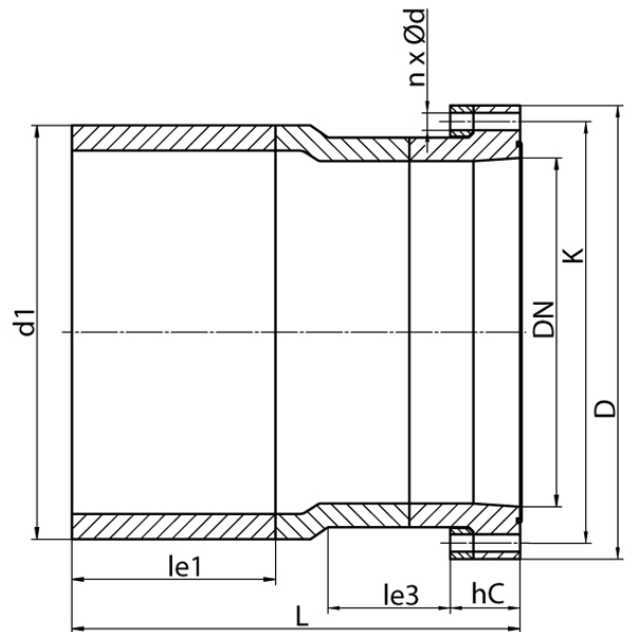

SDR 11



Art. No.	DN [mm]	d1 [mm]	D [mm]	le1 [mm]	le3 [mm]	L [mm]	K [mm]	n	Ød [mm]	M	hC [mm]	kg
4330701106300500	500	630	715	255	190	600	650	20	33	30	105	95,1

Other materials, dimensions and pressure classes on request
 * available for gas pipes with flat surface or NBR-Gaskets

For questions, please feel free to contact us at: Tel. + 49 281 98 414 - 0