

# TEE REDUCED

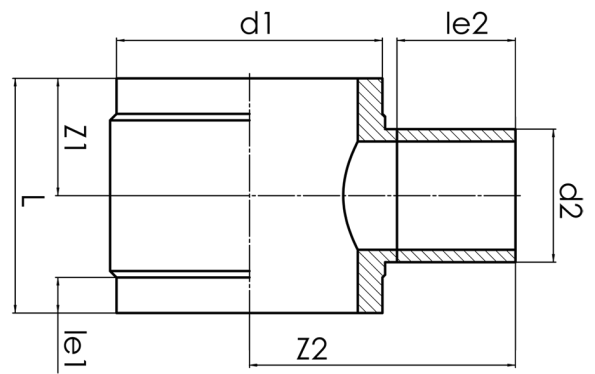

short spigot for butt welding

PE100-RC



## SDR 9



Art. No.	d1 [mm]	d2 [mm]	le1 [mm]	le2 [mm]	L [mm]	z1 [mm]	z2 [mm]	kg
4332200904000225	400	225	75	150	450	225	386	28,3

Other materials, dimensions and pressure classes on request

For questions, please feel free to contact us at: Tel. + 49 281 98 414 - 0