

TEE REDUCED

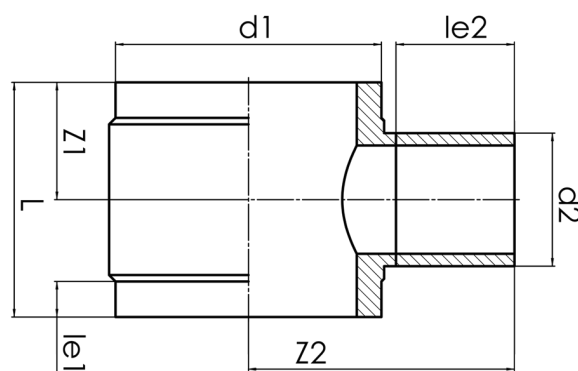

short spigot for butt welding

PE100-RC



SDR 11



| Art. No. | d1 [mm] | d2 [mm] | le1 [mm] | le2 [mm] | L [mm] | z1 [mm] | z2 [mm] | kg |
|------------------|------------|------------|-------------|-------------|-----------|------------|------------|-------|
| 4332201106300200 | 630 | 200 | 75 | 150 | 415 | 208 | 496 | 49,84 |

Other materials, dimensions and pressure classes on request

For questions, please feel free to contact us at: Tel. + 49 281 98 414 - 0