

TEE REDUCED

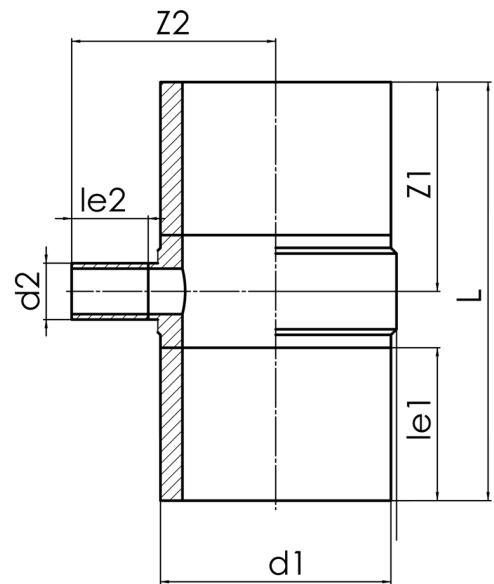

long spigot for butt- and electrofusion welding

PE100-RC



SDR 9



Art. No.	d1 [mm]	d2 [mm]	le1 [mm]	le2 [mm]	L [mm]	z1 [mm]	z2 [mm]	kg
4332300902250180	225	180	150	150	595	298	293	12,41

Other materials, dimensions and pressure classes on request

For questions, please feel free to contact us at: Tel. + 49 281 98 414 - 0