

TEE REDUCED

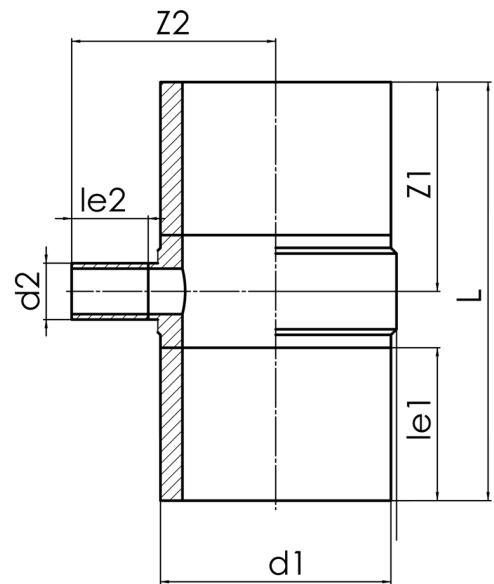

long spigot for butt- and electrofusion welding

PE100-RC



SDR 11



Art. No.	d1 [mm]	d2 [mm]	le1 [mm]	le2 [mm]	L [mm]	z1 [mm]	z2 [mm]	kg
4332301104000315	400	315	300	300	1030	515	531	55,23

Other materials, dimensions and pressure classes on request

For questions, please feel free to contact us at: Tel. + 49 281 98 414 - 0