

TECHNICAL DATA SHEET
TEE ECCENTRIC

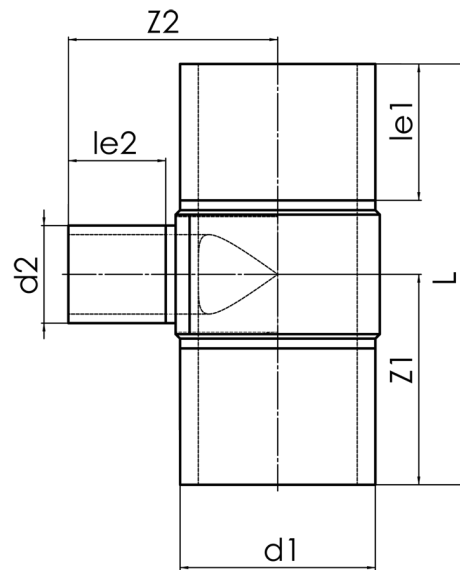

long spigot for butt- and electrofusion welding
 to completely drain the pipeline

PE100-RC

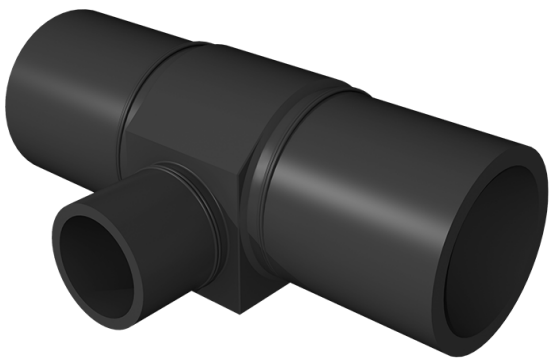

SDR 11



Art. No.	d1 [mm]	d2 [mm]	le1 [mm]	le2 [mm]	L [mm]	z1 [mm]	z2 [mm]	kg
4332311104000140	400	140	300	150	840	420	385	38,41

Other materials, dimensions and pressure classes on request

For questions, please feel free to contact us at: Tel. + 49 281 98 414 - 0