

TECHNICAL DATA SHEET
TEE ECCENTRIC

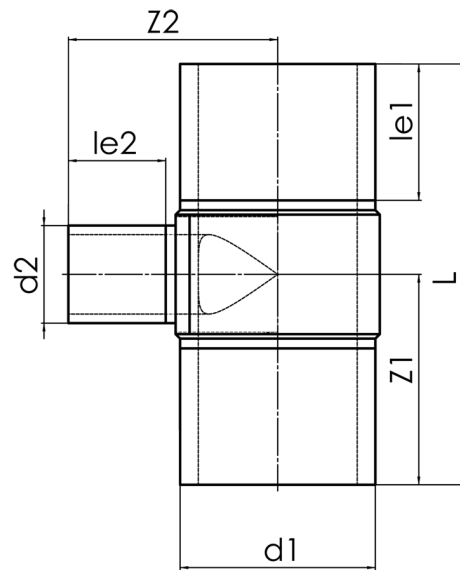

long spigot for butt- and electrofusion welding
 to completely drain the pipeline

PE100-RC

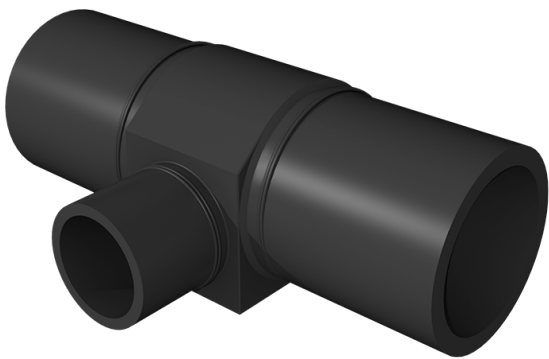

SDR 17



Art. No.	d1 [mm]	d2 [mm]	le1 [mm]	le2 [mm]	L [mm]	z1 [mm]	z2 [mm]	kg
4332311702800140	280	140	250	150	725	363	325	12,2

Other materials, dimensions and pressure classes on request

For questions, please feel free to contact us at: Tel. + 49 281 98 414 - 0