

TECHNICAL DATA SHEET  
**TEE ECCENTRIC**

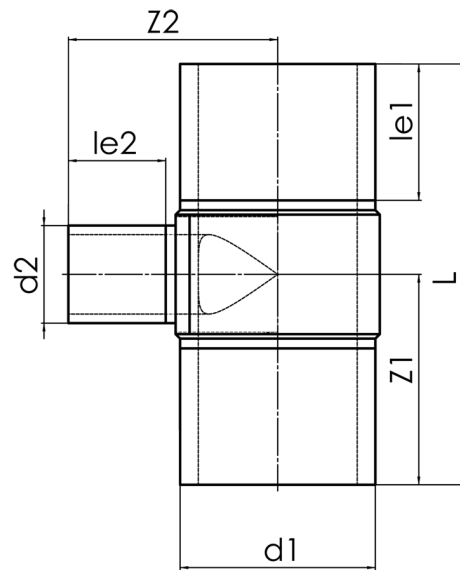

long spigot for butt- and electrofusion welding  
 to completely drain the pipeline

PE100-RC

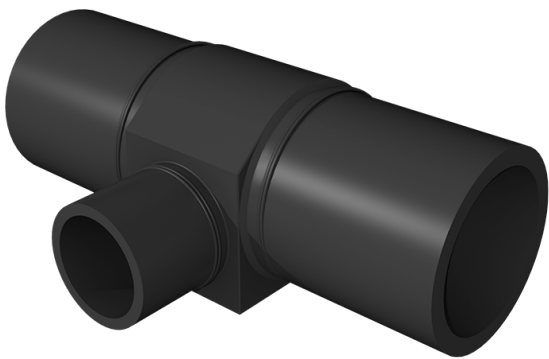

**SDR 17**



Art. No.	d1 [mm]	d2 [mm]	le1 [mm]	le2 [mm]	L [mm]	z1 [mm]	z2 [mm]	kg
4332311704500063	450	63	300	100	750	375	360	28,4

Other materials, dimensions and pressure classes on request

For questions, please feel free to contact us at: Tel. + 49 281 98 414 - 0