

# ELECTROFUSION TEE REDUCED

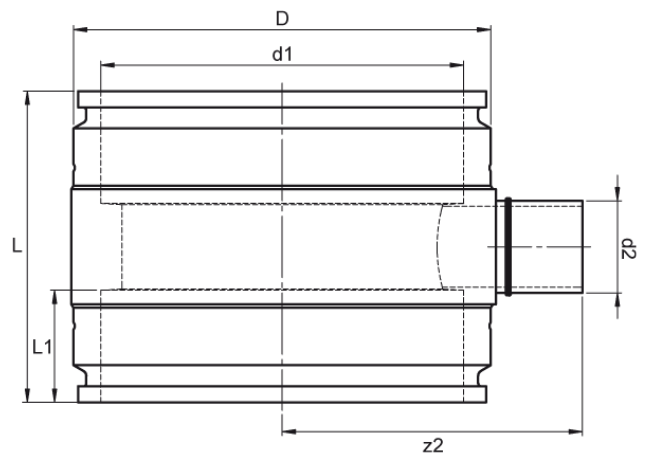

two separate welding zones from d 200 mm  
4,0 mm pin

PE100-RC



## SDR 11



Art. No.	d1 [mm]	d2 [mm]	D [mm]	le2 [mm]	L [mm]	L1 [mm]	z2 [mm]	kg
4332701107100180	710	180	882	150	625	225	621	146,7

Other materials, dimensions and pressure classes on request

For questions, please feel free to contact us at: Tel. + 49 281 98 414 - 0