

ELECTROFUSION TEE REDUCED

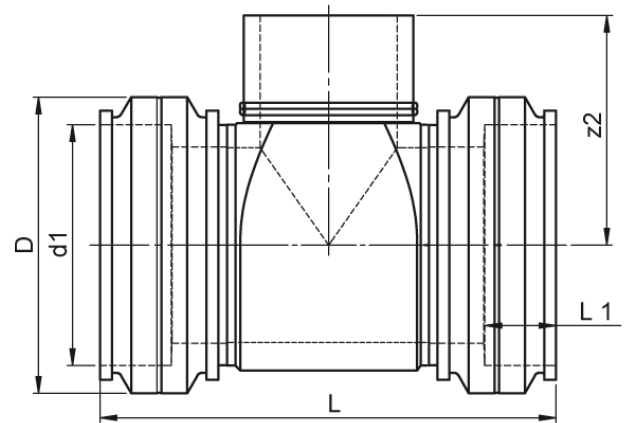

two separate welding zones from d 200 mm
4,0 mm pin

PE100-RC



SDR 11



| Art. No. | d1 [mm] | d2 [mm] | D [mm] | le2 [mm] | L [mm] | L1 [mm] | z2 [mm] | kg |
|------------------|------------|------------|-----------|-------------|-----------|------------|------------|-------|
| 4332701108000400 | 800 | 400 | 993 | 300 | 1355 | 235 | 731 | 324,2 |

Other materials, dimensions and pressure classes on request

For questions, please feel free to contact us at: Tel. + 49 281 98 414 - 0