

ELECTROFUSION TEE REDUCED

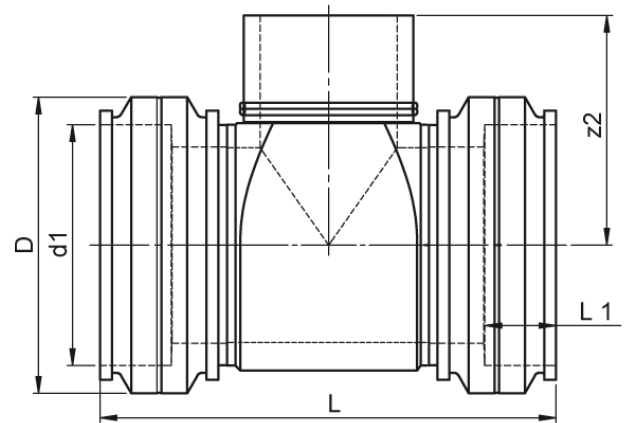

two separate welding zones
4,0 mm pin

PE100-RC



SDR 17



| Art. No. | d1 [mm] | d2 [mm] | D [mm] | le2 [mm] | L [mm] | L1 [mm] | z2 [mm] | kg |
|------------------|------------|------------|-----------|-------------|-----------|------------|------------|-----|
| 4332701708000500 | 800 | 500 | 921 | 350 | 1365 | 235 | 350 | 232 |

Other materials, dimensions and pressure classes on request

For questions, please feel free to contact us at: Tel. + 49 281 98 414 - 0