

# ELECTROFUSION TEE ECCENTRIC

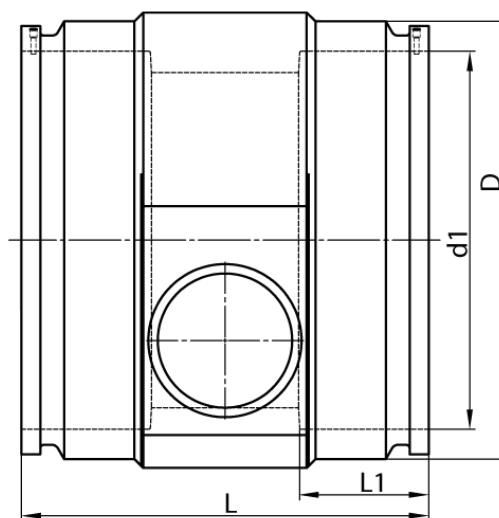

4,0 mm pin  
to completely drain the pipeline

PE100-RC



## SDR 11

Art. No.	d1 [mm]	d2 [mm]	D [mm]	le2 [mm]	L [mm]	L1 [mm]	z2 [mm]	kg
4332711104000280	400	280	499	250	580	165	536	56,3

Other materials, dimensions and pressure classes on request

For questions, please feel free to contact us at: Tel. + 49 281 98 414 - 0