

ELECTROFUSION TEE ECCENTRIC

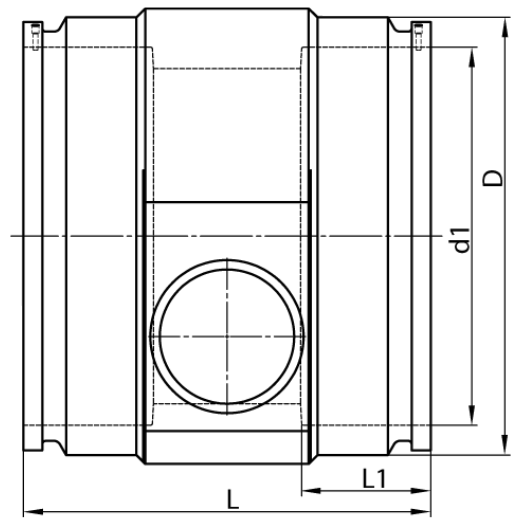

4,0 mm pin
to completely drain the pipeline

PE100-RC



SDR 11

Art. No.	d1 [mm]	d2 [mm]	D [mm]	le2 [mm]	L [mm]	L1 [mm]	z2 [mm]	kg
4332711109000125	900	125	1115	150	650	260	750	216,4

Other materials, dimensions and pressure classes on request

For questions, please feel free to contact us at: Tel. + 49 281 98 414 - 0